

## Supplément jeux

### Activité 1

Combien de cubes ont-ils été retirés ? **Comptez, calculez.**

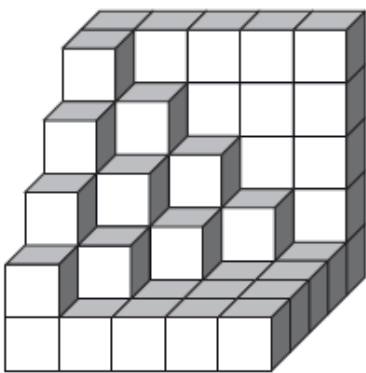

A

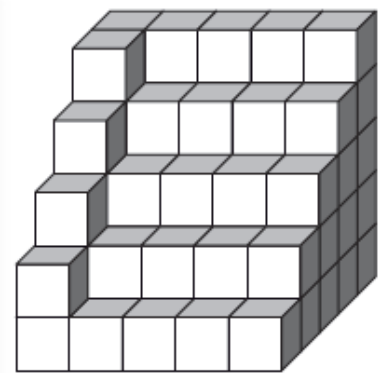
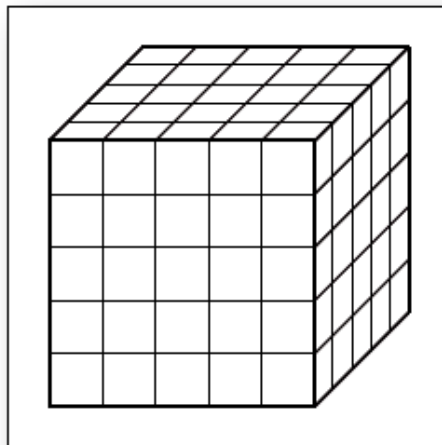

B

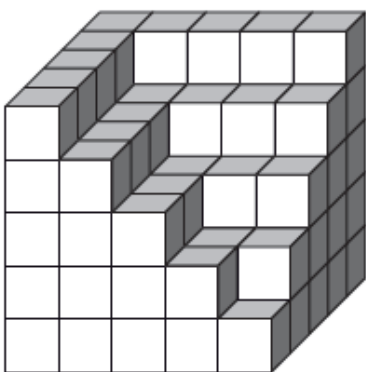

C

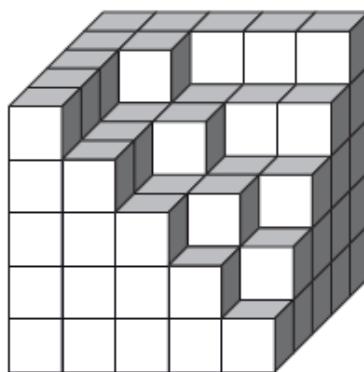

D

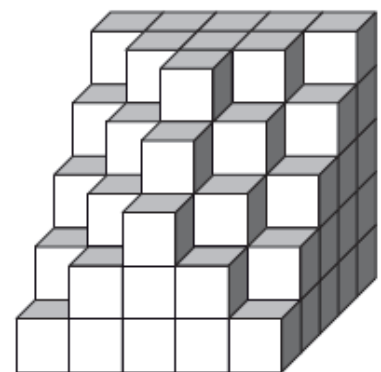

E

## Activité 2

Un parcours de nombre. Complétez ce parcours en effectuant les opérations demandées.

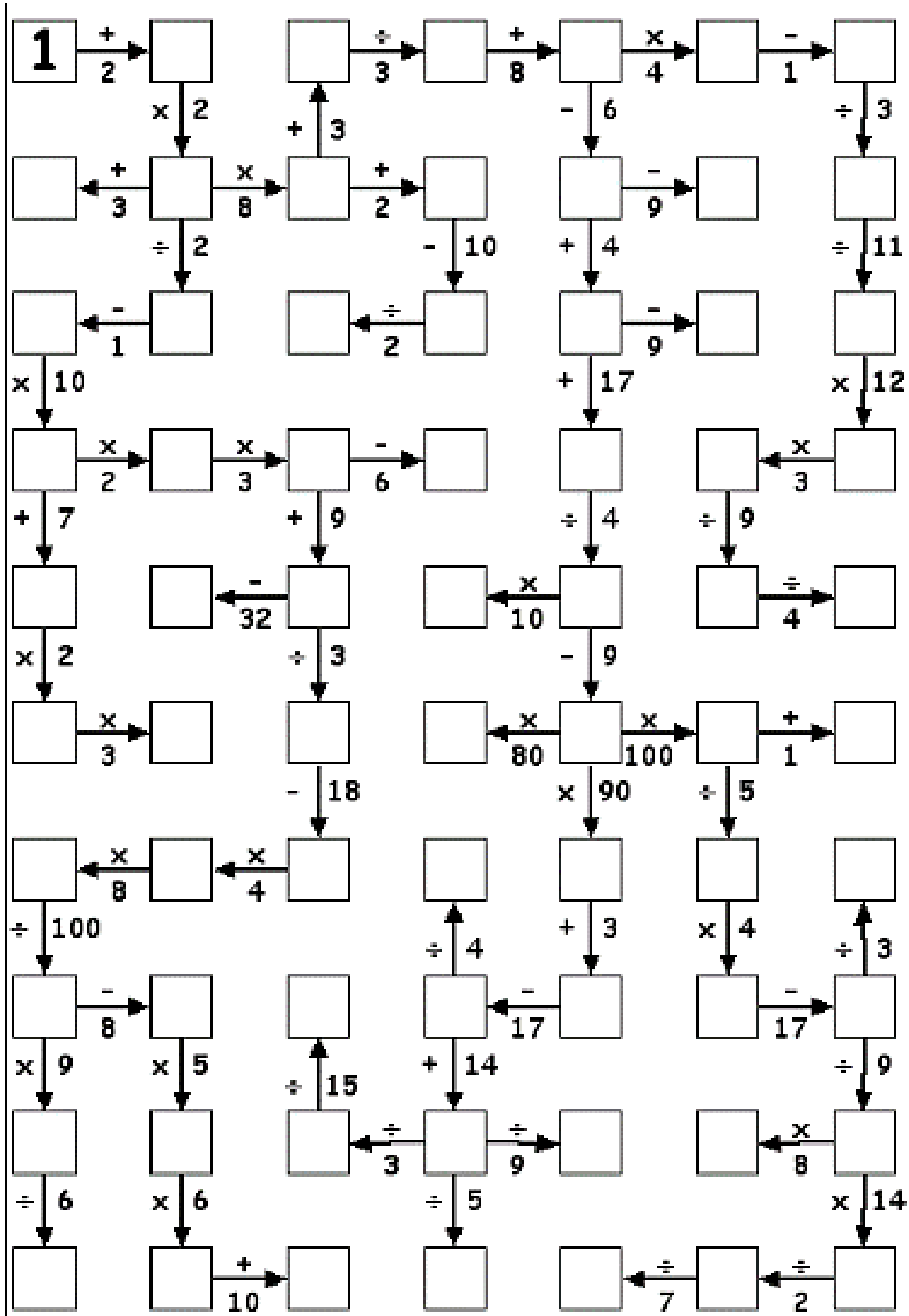

## Activité 3

Des histoires de Ferdinand à reconstituer. **Découpez** chaque image et **reconstituez** 3 planches qui racontent une histoire complète. **Dites** cette histoire à voix haute.

### Planche N°1.

--	--	--	--



### Planche N°2.

--	--	--	--



### Planche N°3.

--	--	--	--

